

Hamade Squid Fishing Machine has won the Robot Award of the Year in 2006.



The latest model with further evolutions

Automatic

Squid Jigging/Fishing Machine

High Quality Squid Fishing Machine System

EX-2N

Patented in Japan

A day and night all-round player was born. The latest technology and high power realize smooth and sharp jigging.



Innovative Design

New Arrival

Carbon Round Drum

New drum with a new concept of pipe-less structure that achieves light weight, strength and corrosion resistance.

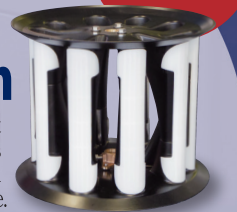

Weight ratio to our previous model

Astonishing 30% reduction

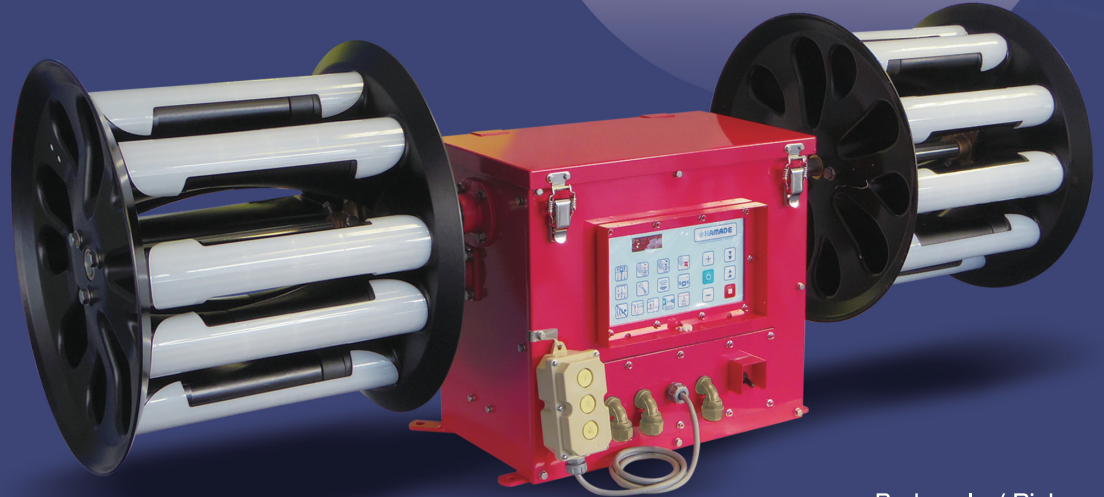

Body color/ Pink

From Hakodate to the world ~ aiming to provide an ocean-friendly work environment ~

Towa Denki Seisakusho, Inc.



New concept of 600W motor offers both high power and usability.

New space design between the shaft and the screw axis. The improved gear ratio enables speedy winding down and sharp jiggging. In addition, the wire entwining detection function reduces line trouble and dramatically improves fishing performance.

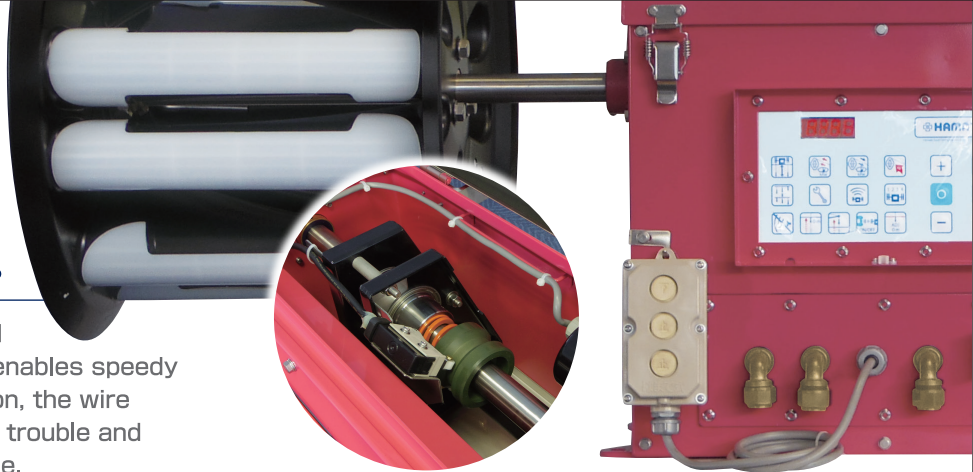

New Arrival **Triaxial Gravity Sensor**

Processes all types of ship motion, with high speed and precision, in three dimensions. The drum rotation promptly follows the ship motions to keep the tension on the fishing line constant.

- ◎Fishing line coming off the tip roller
- ◎Hooked squids got escaped
- ◎Trouble with fishing line breaking

Patent Pending in Japan

decrease significantly!

Adopted the reputable LCD control panel.

Standard remote control unit

Up/Down/Pause standard remote control unit

16 circuits

Up/Down/Pause standard remote control unit

32 circuits

Central Control Panel

Performs a variety of jiggging patterns!

The variety of jiggging patterns are flexible and can be freely set to meet the situation.

Jiggging List Window Octant Jiggging Setting Window Jiggging strength Setting Window

Specification	Specification
Poewr Supply	AC220V 3Ø 50/60Hz
Depth	1.0~999.9m
Jiggging Tension	Setting Range / 5~80 (max.70kg)
Number of drum revolutions	5~170rpm (when winding up / 5~160rpm)
Motor	Geared motor for Ikarobot

Manufacturer and distributor

HAMADE <http://www.towa-denki.co.jp>
Towa Denki Seisakusho, Inc.

6-29 Yoshikawa-cho, Hakodate-city, Hokkaido 040-0077
 PHONE +81-138-41-4410 FAX. +81-138-41-2867

Full view Outline drawing

■ Squid Jiggging/Fishing Machine

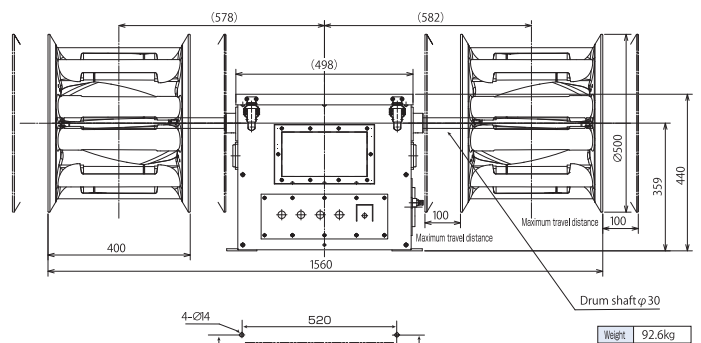

■ Central Control Panel

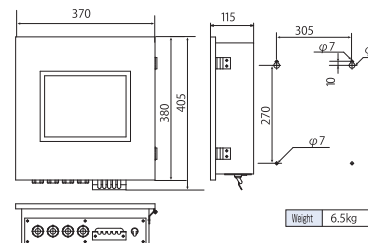

■ Standard remote control unit

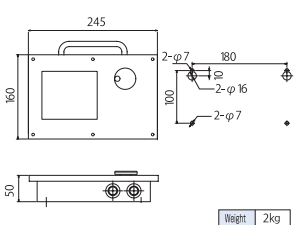

■ Up/Down/Pause standard remote control unit

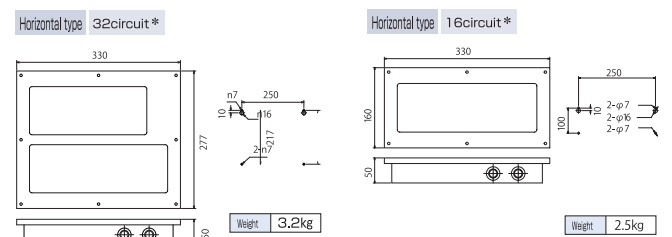

※ 8 circuits are also available.

Agency