

Hamade Squid Fishing Machine has won the Robot Award of the Year in 2006.



With a new crystal control panel, you can enjoy an even clearer display and improved functionality.

New Automatic Squid Fishing Machine

High Quality Squid Fishing Machine System

MY-8

The product is fully patented.

A new version of the squid fishing machine with the popular crystal control panel and increased functionality

The new crystal control panel features a display surface that is easier to see, while it also offers improved functionality.



body color / red

From Hakodate to the world ~ aiming to provide an ocean-friendly work environment~

Towa Denki Seisakusho, Inc.

 HAMADE

105E

MY-8



It is a simple fishing machine with its focus firmly on functionality.

It is equipped with our popular crystal control panel.

The control panel can monitor up to 64 fishing machines in addition to being capable of self-diagnosing the system in a short amount of time.

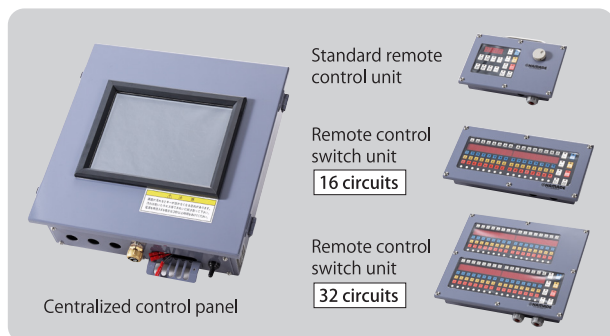

New You can enjoy diverse types of jigging

There are many ways of jigging and, with this new machine that allows multiple settings, you can enjoy fishing squids the way you like depending on the situation.

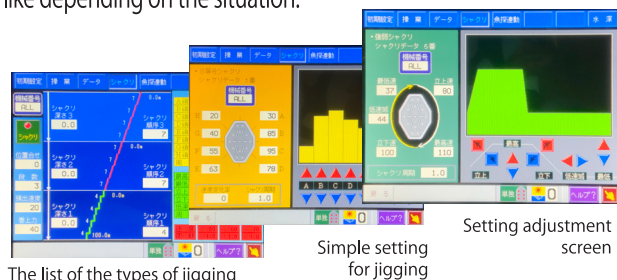

The list of the types of jigging

Simple setting for jigging

Setting adjustment screen

Fish finder function

The popular fish finder function is embedded in the main microcontroller unit.

The display is multilingual.

The centralized control panel will be a LCD touch panel, and the display languages will include Chinese, Korean and English.

Help (icon)

When you can't figure out how to use the panel, you can just touch "Help" on the screen and then the answer will be displayed.

New A panel with a display surface with icons

The display of the new control panel that features icons allows you to work instantly and instinctively and, as a result, you can work much more efficiently.



Full view

Outline drawing

■ Squid Fishing Machine (body)

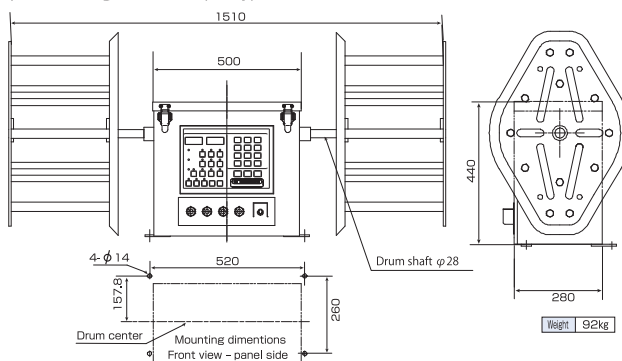

■ Centralized control panel

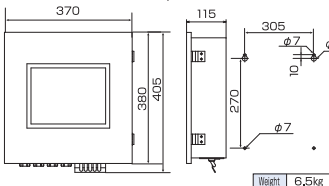

■ Standard remote control unit

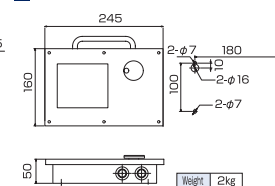

■ 上下止標準速隔操作ユニット

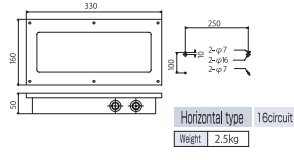
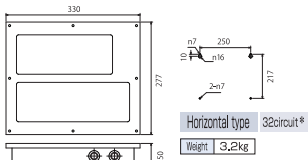

*8-circuit type is also available

Specification

Specification	Specification
Power supply	AC220V 3 ϕ 50/60Hz
Depth of the sea	1.0~999.9m
Hoisting power	Setting range / 5~80 (maximum of 90kg)
Drum rotation speed	5~170 rpm (when hoisting / 5~160 rpm)
Motor	Geared motor specifically designed for squid fishing machines

Options

Drum options

Round or diamond shaped drum depending on your preference

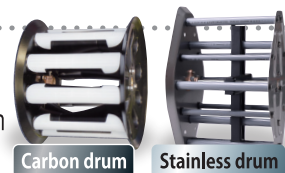

Manufacturer and distributor

HAMADE <http://www.towa-denki.co.jp>
Towa Denki Seisakusho, Inc.

6-29 Yoshikawa-cho, Hakodate-city, Hokkaido 040-0077
PHONE +81-138-41-4410 FAX. +81-138-41-2867

Agency