



LCD control panel with color for better visibility and operability.

New Model Automatic Squid Jigging/Fishing Machine

High Quality Squid Fishing Machine System

MY-18

Patented in Japan

New upgraded model with the reputable LCD control panel and the wide variety of functions.

The latest model with the newly developed Triaxial Gravity Sensor

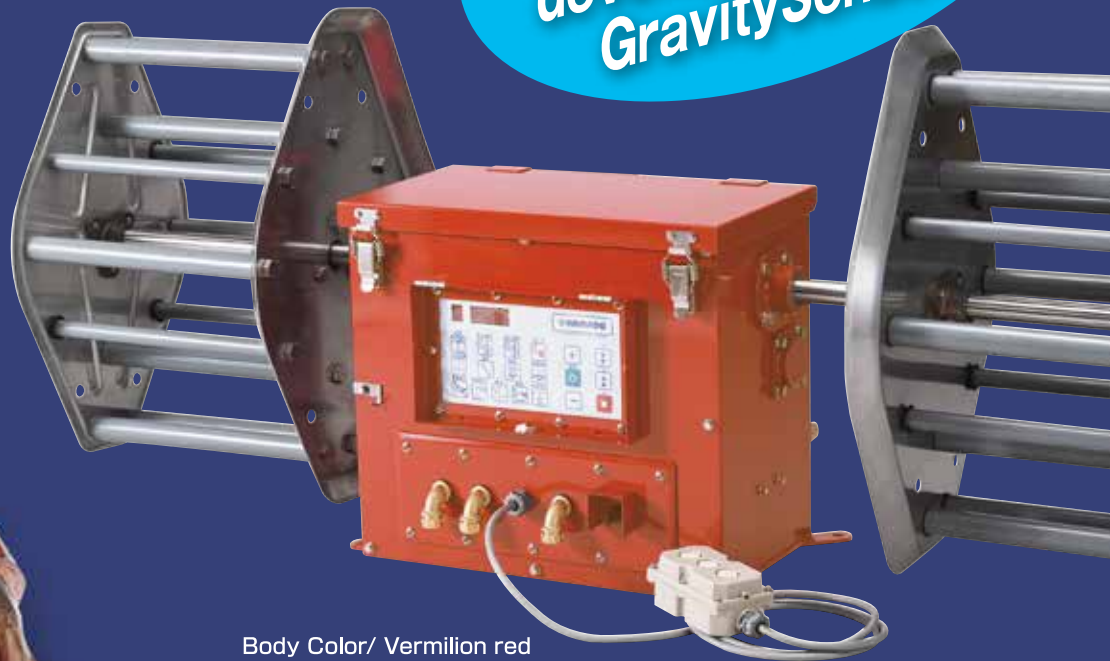

Body Color/ Vermilion red

From Hakodate to the world ~ aiming to provide an ocean-friendly work environment ~

Towa Denki Seisakusho, Inc.



New

Triaxial Gravity Sensor

Patent Pending in Japan

Processes all types of ship motion, with high speed and precision, in three dimensions. The drum rotation promptly follows the ship motions to keep the tension on the fishing line constant.



- Fishing line coming off the tip roller
- Hooked squids got escaped
- Trouble with fishing line breaking

decrease significantly.

Reputable LCD control panel adopted



Central Control Panel

Standard remote control unit

Up/Down/Pause standard remote control unit

16 circuits

Up/Down/Pause standard remote control unit

32 circuits

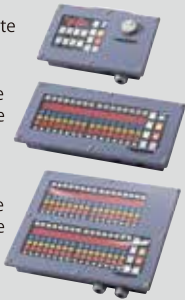

Performs a variety of jigging patterns!

The variety of jigging patterns are flexible and can be freely set to meet the situation.



Fishfinder Linkage Function

HELP picture

Ship Motions

Specification	Specification
Powr Suppy	220VAC 3Ø 50/60Hz
Depth	1.0~999.9m
Jigging Tension	Setting Range / 5~80 (max.80kg)
Number of drum revolutions	5~170 rpm (when winding up / 5~160 rpm)
Motor	Geared motor for Ikarobot

Manufacturer and distributor

HAMADE <http://www.towa-denki.co.jp>

Towa Denki Seisakusho, Inc.

6-29 Yoshikawa-cho, Hakodate-city, Hokkaido 040-0077
PHONE +81-138-41-4410 FAX. +81-138-41-2867

New motor installed



The 600W motor with new technology concept improves power in high range.

New icon panel display



The operation panel displays icons. Intuitive operations allow for much more efficiency.

New

Strong Type

- Strengthened body
- 30mm spindle and reinforced chain



External dimensions

Outline drawing

■ Squid Jigging/Fishing Machine

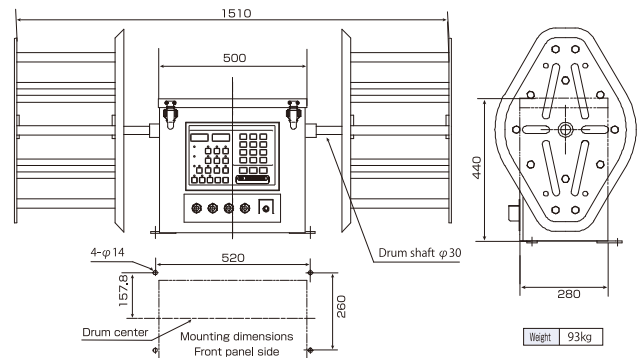

■ Central Control Panel

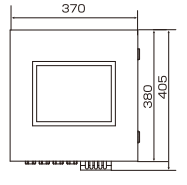

■ Standard remote control unit

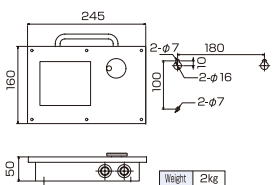

■ Up/Down/Pause standard remote control unit

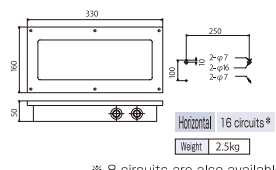
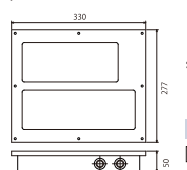

※ 8 circuits are also available.

Options

Choice of drums

Round and diamond-shaped drums in a choice of preferable material.

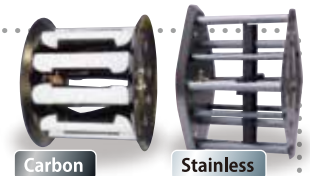

Carbon

Stainless

Agency